



System No. W-L-2255

December 20, 2001

F Ratings — 1 and 2 Hr (See Item 1)

T Ratings — 1 and 1-1/2 Hr (See Item 1)

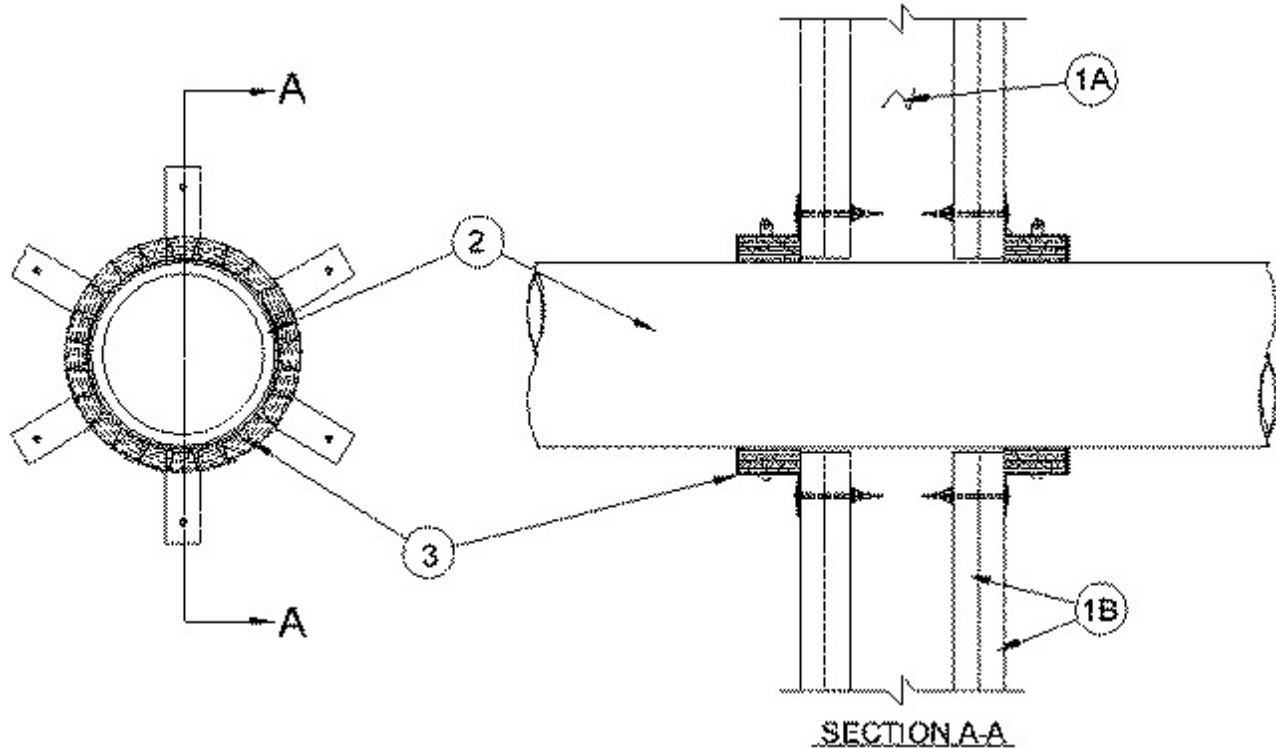

1. Wall Assembly — The 1 or 2 hr fire-rated gypsum board/stud wall assembly shall be constructed of the materials and in the manner specified in the individual U300 or U400 Series Wall and Partition Designs in the UL Fire Resistance Directory and shall include the following construction features:

A. Studs — Wall framing may consist of either wood studs or steel channel studs. Wood studs to consist of nom 2 by 4 in. lumber spaced 16 in. OC. Steel studs to be min 3-1/2 in. wide and spaced max 24 in. OC.

B. Gypsum Board* — One or two layers of nom 5/8 in. thick gypsum board, as specified in the individual Wall and Partition Design. Max diam of opening is 5 in.

The hourly F Rating of the firestop system is equals to the hourly fire rating of the wall assembly. When 2 hr wall is used, T Rating is 1-1/2 hr. When 1 hr wall is used, T Rating is 1 hr.

2. Nonmetallic Pipe — Nom 4 in. diam (or smaller) Schedule 40 (or heavier) fire retardant polypropylene (FRPP) pipe for use in closed (process or supply) or vented (drain, waste or vent) piping systems. One pipe to be installed concentrically or eccentrically within the firestop system with an annular space of min 0 in. (point contact) to max 1/2 in. Pipe to be rigidly supported on both sides of wall assembly.

3. Firestop Device* — Galv steel collar lined with an intumescent material sized to fit specific diam of the through penetrant. Device to be installed around through penetrant in accordance with accompanying installation instructions. Device incorporates anchor tabs for securement to both surfaces of the wall by means of 1/8 in. diam by 2-1/2 in. long steel hollow wall anchors with 1/4 in. by 5/8 in. washers at each anchor tab.

*Bearing the UL Classification Mark